

# ProMariner®

ProMariner®  
ADVANCED ON-BOARD CHARGERS

Putting you on the water first with power to last

More choices with our exclusive 

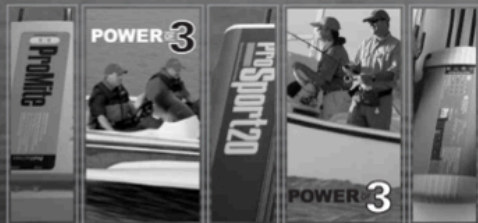

Professional Mariner, LLC  
200 International Drive, STE 195  
Portsmouth, New Hampshire 03801  
TEL: 603-433-4440  
FAX: 603-433-4442  
www.promariner.com

specifications subject to change without notice

# ProMariner®

## ProSport Series

Heavy Duty Recreational Grade On-Board Marine Battery Charger

### Owner's Manual and Installation Guide



### Distributed-On-Demand™ Charging

Fully Automatic / Electronic Multi-Stage Marine Battery Chargers

Models	Bank Config.	Total Amps Distributed	Use with # of Batteries	Battery System
ProSport6	Single	6 Amps	1	12 VDC
ProSport8	Dual	8 Amps	2	12/24 VDC
ProSport12	Dual	12 Amps	2	12/24 VDC
ProSport20	Dual	20 Amps	2	12/24 VDC
ProSport20 Plus	Triple	20 Amps	3	12/24/36 VDC

#### IMPORTANT NOTICE

Please save and read all safety, operating and installation instructions before installing or applying AC power to your ProMariner ProSport On-Board Marine Battery Charger.

#### Your Satisfaction is Important to Us!

Do not return this product to your local retail location. Please call ProMariner at the number below for any service or warranty requirements.

Please visit our website at [www.promariner.com](http://www.promariner.com) for any warranty, service or installation assistance and FAQ's or call our Customer Care Department at 800-824-0524 from 8:30 am to 5 pm (Eastern Time).

#### PLEASE RECORD YOUR:

Model Number: \_\_\_\_\_ Serial Number: \_\_\_\_\_ Date of Purchase: \_\_\_\_\_

(Serial number can be located on the top side of the mounting flange.)



▶ Visit ProMariner Online at [www.promariner.com](http://www.promariner.com), for a Complete Selection of Quality Marine Products...

Here are just a few:

- ▶ ProMite Series - Recreational Grade Waterproof Marine Battery Chargers
- ▶ ProTournament Series - Professional Grade Waterproof Marine Battery Chargers
- ▶ ProNautic C<sup>3</sup> Series All Digital Dry Mount Battery Chargers
- ▶ ProTech-i Series Dry Mount Battery Chargers
- ▶ Digital Mobile Charge In-Transit Chargers
- ▶ Battery Maintainers
- ▶ AC Plug Holders
- ▶ Battery Isolators
- ▶ Isolation Transformers
- ▶ Galvanic Isolators and Monitored Systems
- ▶ Corrosion Control Products
- ▶ Waterproof Marine Binoculars
- ▶ Gold Plated Fuses and Holders
- ▶ A Complete Line of Hand Held Test Meters
- ▶ Online Technical Support and Service Support

Visit frequently, we are always adding new products for your boating enjoyment!

## ▶ Customer Service & Warranty

We are committed to customer satisfaction and value your business. If at any time during the warranty period you experience a problem with your new ProSport On-Board Marine Battery Charger, simply call us at 1-800-824-0524 for technical support or email [info@promariner.com](mailto:info@promariner.com).

WARRANTY CARD CAN BE REGISTERED AT [WWW.PROMARINER.COM](http://WWW.PROMARINER.COM) or the warranty card included in this manual can be completed and sent to ProMariner by mail.

### PROSPORT LIMITED TWO-YEAR FACTORY WARRANTY

Each ProSport model is guaranteed against defects in material and workmanship to the original consumer in normal use for 2 years from the date of purchase. Professional Mariner, LLC will at its discretion repair or replace free of charge any defects in material or workmanship. The following conditions apply:

- Warranty is calculated from manufacture date if not registered within two weeks of sale.
- Warranty void if unauthorized repairs attempted.
- Customer is responsible for returning the product to Professional Mariner, LLC. Inbound shipping costs must be prepaid.
- This warranty does not cover blemishes due to normal wear and tear or damaged caused by accidents, abuse, alterations or misuse.
- Cosmetic repairs can be done at owner's request and expense.

Purchase or other acceptance of the product shall be on the condition and agreement that Professional Mariner SHALL NOT BE LIABLE FOR INCIDENTAL OR CONSEQUENTIAL DAMAGES OF ANY KIND. (Some states do not allow the exclusion or limitation of incidental or consequential damages, so the above limitations may not apply to you.) This warranty is made in lieu of all other obligations or liabilities on the part of Professional Mariner. Professional Mariner neither assumes nor authorizes any person for any obligation or liability in connection with the sale of this product.

To make a claim under warranty, go to [www.promariner.com](http://www.promariner.com) and click on the support tab and follow the instructions making sure to identify the product and the problem. If you can not use our online warranty claim registration, please feel free to call ProMariner at the toll free number listed below. Professional Mariner will make its best effort to repair or replace the product, if found defective within the terms of the warranty, within 30 days after return of the product to the company. Professional Mariner will ship the repaired or replaced product back to the purchaser.

This warranty gives you specific legal rights, and you may also have other rights, which vary from state to state. This warranty is in lieu of all others expressed or implied.

Factory Service Center & Technical Support  
Professional Mariner, LLC  
200 International Drive, STE 195  
Portsmouth, NH 03801  
Tel: 1-800-824-0524

Professional Mariner, LLC  
Tel: (603) 433-4440 / Fax: (603) 433-4442

[www.promariner.com](http://www.promariner.com)

## Specifications

Model	Bank Config	Total Amps Distributed	Use w/ # of Batteries	Battery System	DC Cable Length	Size L x W x H	Weight	AC Input Voltage
ProSport6	single	6	1	12 VDC	5'	5.75" x 7.25" x 2.5"	6 lbs	90-135
ProSport8	dual	8	2	12/24 VDC	5'/5'	7" x 7.25" x 2.5"	8 lbs	90-135
ProSport12	dual	12	2	12/24 VDC	5'/5'	8.5" x 7.25" x 2.5"	9 lbs	90-135
ProSport20	dual	20	2	12/24 VDC	5'/5'	10.75" x 7.25" x 2.5"	10 lbs	90-135
ProSport20 Plus	triple	20	3	12/24/36 VDC	5'/5'/5'	10.75" x 7.25" x 2.5"	11 lbs	90-135
ProSport 1.5 Portable	single	1.5	1	12 VDC	4'	2.2" x 2.5" x 3.3"	1.5 lbs	95-135
ProSport 1.5 On-Board	single	1.5	1	12 VDC	4'	2.2" x 3.5" x 3.9"	1.75 lbs	95-135

## Accessories

### ProSport 1.5 Battery Maintainers

Fully automatic, with built-in safety. LED status indicator, 1-year warranty



### ProMariner & Universal Plug Holders

Secure your AC plug with an easy to mount plug holder. No cutting or stripping of wires required. Safe and easy to use. Choose from two colors, black or white.



### Remote Battery Bank Status Monitor

Remote "Push to Test" Status indicators for up to 3 Batteries with easy to read LED indicators. Universal flush or surface mount capable



### Battery Bank Cable Extenders

No cutting, stripping, or splicing wires! 2 convenient sizes to choose from 5' or 15'. Gold plated terminals, in line fuses & Hardware included

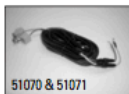

Model	Part No.	Cable Length	Volts	Banks
Handheld DC System Tester	87710	n/a	n/a	n/a
Remote Battery Bank Status Monitor	51060	10'	12	3
ProSport AC Plug Holder (white)	51200	n/a	n/a	n/a
ProSport AC Plug Holder (black)	51201	n/a	n/a	n/a
Universal AC Plug Holder (black)	51202	n/a	n/a	n/a
Universal AC Plug Holder (white)	51203	n/a	n/a	n/a
15' Battery Bank Cable Extender	51070	15'	n/a	n/a
5' Battery Bank Cable Extender	51071	5'	n/a	n/a

To place an order contact your local dealer or ProMariner at:  
603-433-4440 / Fax: 603-433-442 / [www.promariner.com](http://www.promariner.com)

## Table Of Contents

Safety Instructions...	pages 1-2
ProSport Overview...	pages 3-6
Selecting a Charging Profile & Understanding Battery Types	page 7
Installation Guidelines...	pages 7-11
DC Wiring Diagrams	pages 9-11
Charging Your Batteries...	page 12
Maintenance...	page 13
Trouble Shooting...	page 14
Specifications & Accessories...	page 15
Customer Service & Warranty...	page 16

## Introduction

Thank you from all of us at Professional Mariner and congratulations on your recent purchase of the ProMariner ProSport On-Board Marine Battery Charger.

Powered and designed by ProMariner®, a leader in the marine charging industry for over 30 years; ProSport, the first choice in waterproof on-board marine battery chargers, has been re-engineered to deliver the latest in multi-stage charging and industry leading features like our: All new digitally controlled battery type selector, expanded LED status center and Distributed-On-Demand™ Charging Technology for faster charging.

Please save and read this manual carefully and fully understand the safety instructions before installing your new ProSport Marine Battery Charger.

## ▶ General Safety Instructions

Before connecting your batteries or applying AC power, read all instructions and cautionary markings on the battery charger, cables, and batteries.

**CAUTION** - To reduce the risk of injury, charge only Lead-acid type rechargeable batteries; Flooded (Lead-acid), Sealed (Lead-acid), GEL (Gelled Electrolyte Lead-acid) and AGM (Absorbed Glass Mat). Other types of batteries may burst, causing personal injury. **The ProSport is factory set for standard Flooded (Lead-acid) /AGM (Absorbed Glass Mat) batteries.**

Use of attachments not recommended or sold by Professional Mariner, LLC may result in a risk of fire, electrical shock or personal injury.

Do not operate the charger if it has received a sharp blow, direct hit of force, been dropped or otherwise damaged in any way. Do not install if any protective AC and DC cable insulation, DC fuse holders and/or ring terminals have been damaged or compromised. Call ProMariner for repair service to avoid risk of fire, short circuits or electrical shock.

Do not disassemble the battery charger. If service or repair is required please contact customer care at 1-800-824-0524. Incorrect reassembly or cable modifications may result in a risk of electrical shock, fire or explosion.

To reduce the risk of electrical shock, remove AC power from the charger prior to any maintenance or cleaning.

### **WARNING: RISK OF EXPLOSIVE GASES**

WORKING IN THE VICINITY OF A LEAD-ACID BATTERY IS DANGEROUS. BATTERIES GENERATE EXPLOSIVE GASES DURING NORMAL BATTERY OPERATION. FOR THIS REASON IT IS OF EXTREME IMPORTANCE THAT EACH TIME BEFORE USING YOUR CHARGER YOU FOLLOW THESE SAFETY INSTRUCTIONS.

### **⚠ WARNING AVOID SERIOUS INJURY OR DEATH FROM FIRE, EXPLOSION, OR ELECTRICAL SHOCK**

- Make your AC power connection in an open atmosphere free of explosive fumes.
- Make your AC power connection in a secure manner that will avoid contact with water.

To reduce risk of battery explosion, follow these instructions and those published by the battery manufacturer, and of any equipment you intend to use in the vicinity of a battery. Review all cautionary markings and labels.

## ▶ Personal Safety Precautions

- a) Someone should be within the range of your voice or close enough to come to your aid when working near a Lead-acid battery.
- b) Have plenty of soap and water nearby in case battery acid comes in contact with skin, clothes, or eyes.
- c) Wear complete eye protection and clothing protection. Avoid touching eyes while working near battery(s).
- d) If battery acid contacts skin or clothing, wash immediately with soap and water. If acid enters eye, immediately flood eye with running cold water for at least 10 minutes and get medical attention immediately.

## ▶ Trouble Shooting Guide

### **NO Blue AC Power LED or RED Charging & Battery Type LED**

Check for loss of AC power at the 120VAC outlet. Confirm GFCI (Ground Fault Circuit Interrupter) has not tripped. Check with a meter or 120VAC test light that AC power is present at the end or your extension cord.

Confirm all charger cables are installed with the correct polarity connections at each battery and that all connections are clean and tight.

With the AC power removed and the engine off, check the charge level of each battery with a DC meter or Handheld DC Tester. If there is no charge level indication for a battery, check each battery with a hydrometer to determine if it has one or more bad cells. (batteries should always be replaced in sets, and always the same type.)

If everything above checks out OK, contact ProMariner at 1-800-824-0524 from 8:30 am to 5pm Eastern Time. If your ProSport is within the warranty period of 2 years from the date of purchase, you can go to [www.promariner.com](http://www.promariner.com) where you will find our customer care return form and instructions.

### **Battery(s) are not charging, Blue AC Power LED, RED Charging & Battery Type LEDs are On**

Confirm all charger cables are installed with the correct polarity connections at each battery, and that all connections are clean and tight. *Reverse polarity connections will blow output fuse, resulting in no output voltage.*

With the charger on, read DC voltage at each battery. If any of the readings are less than 13 Volts DC proceed with the following:

- A. Disconnect AC power at the 120VAC outlet.
- B. Remove charger cables from each battery.
- C. Reconnect AC power and read DC Voltage across each output cable, if output voltage is approximately 13.4 Volts DC the charger is ok and each battery should be tested with a hydrometer with the charger and engine off to determine if one or more batteries have bad cells. (batteries should always be replaced in sets, and should always be the same type.)
- D. If there is no output when trying to read DC voltage check each output fuse and replace as needed.

If the DC Output Voltage is less than 13 Volts DC, contact ProMariner at 1-800-824-0524 from 8:30 am to 5pm Eastern Time. If your ProSport is within the warranty period of 2 years from the date of purchase, you can go to [www.promariner.com](http://www.promariner.com) where you will find our customer care return form and instructions.

### Optional Battery Bank Status Monitor

See your local dealer or retailer for the ProMariner Remote Battery Bank Status Monitor. The Remote Monitor is easy to install and connects directly to your boat's batteries. Once installed, simply hold down the "Push-To-Test" button and observe the charge level indicator for each battery (up to 3 batteries can be monitored). **Note: AC power to the battery charger and the boat's engine must be off when using the Remote Battery Bank Status Monitor.**

### Important Notice: FCC Class A Part 15 Notification.

Your ProSport On-Board Marine Battery Charger has been designed and tested to comply with FCC Class A part 15. These regulations are to provide adequate protection against harmful interference while operated in a commercial application. If in a residential setting, you are encountering interference with TV and radio reception, simply remove AC power from the ProSport to confirm if your battery charger is causing interference. End user can explore the following to minimize interference:

- 1) Chose a different AC circuit to power your On-Board Marine Battery Charger.
- 2) Make sure your outlet is properly grounded.
- 3) Re-position receiving antenna.
- 4) Purchase a separate AC line filter.
- 5) Relocate charger so that it is at the furthest point from home receiving equipment, TV, radio, etc.

### Owner's Periodic Maintenance Guide

<b>Item:</b>	<b>Battery Connections</b>
<b>Process:</b>	Clean and tighten all battery connections. Follow battery manufacturer's instructions for cleaning a battery. Clean all battery terminals with a wire brush where required and tighten all battery connections.
<b>When:</b>	Monthly
<b>Item:</b>	<b>Battery Electrolyte</b>
<b>Process:</b>	Per battery manufacturer's instructions, monitor, and maintain proper levels of distilled water in each battery.
<b>When:</b>	Monthly
<b>Item:</b>	<b>ProSport DC Output Wiring</b>
<b>Process:</b>	Visually inspect all wiring for cuts and abrasions. Contact ProMariner if your charger needs to be serviced with new wiring.
<b>When:</b>	Monthly
<b>Item:</b>	<b>AC Power Cord and Mounting Hardware Inspection</b>
<b>Process:</b>	Visually inspect the AC power cord. Confirm ground blade is present and all plug blades are in good condition and not bent out of place.  Check all mounting hardware to ensure there is no loose hardware. Tighten where required.
<b>When:</b>	Monthly

### Personal Safety Precautions Continued

e) NEVER smoke or allow a spark or flame in the vicinity of a battery or engine.

**CAUTION** - To reduce the risk of injury, charge only Lead-acid type rechargeable batteries; Flooded (Lead-acid), Sealed (Lead-acid), GEL (Gelled Electrolyte Lead-acid) and AGM (Absorbed Glass Mat). Other types of batteries may burst, causing personal injury. **The ProSport is factory set for standard Flooded (Lead-acid)/AGM (Absorbed Glass Mat) batteries.**

Incorrect assembly or modification may result in risk of electrical shock, fire, or explosion.

f) Be extra cautious to reduce risk of dropping a metal tool onto the battery. It might spark or short-circuit a battery or other electrical hardware which may cause an explosion or fire.

g) Remove all personal metal items such as rings, bracelets, necklaces, watches, and jewelry when working near a battery. A battery can produce a short circuit current high enough to weld a ring or any other metal, causing serious burns.

**Use your ProSport On-Board Marine Battery Charger to charge: Flooded (Lead-acid)/AGM (Absorbed Glass Mat) GEL (Gelled Electrolyte Lead-acid) Batteries.** It is not intended to supply low voltage electrical systems other than in a marine application. Do not use your marine battery charger to charge dry cell batteries that are commonly used with home appliances. These batteries may burst and cause injury to persons and property.

**Never charge a frozen battery**

### Safety Precautions Prior to Charging Batteries

If necessary to remove a battery from a boat to charge, **always remove the grounded negative terminal from the battery first.** Make sure all accessories in the boat are off, as to not cause an arc.

Be sure the area around the charger and batteries is well ventilated while the batteries are being charged. Gases can be forcefully blown away using a piece of cardboard or other nonmetallic material as a fan.

Clean battery terminals with full eye protection to prevent corrosive material from coming in contact with eyes.

Add distilled water in each cell until electrolyte reaches levels specified by the battery manufacturer. This helps purge excessive gases from cells. Do not overfill. For batteries without caps, carefully follow manufacturer's recharging instructions.

Study all manufacturer's specific precautions, such as removing or not removing cell caps while charging, in addition to battery type for proper rate of charge.

Extension cords should be industrial grade / heavy duty UL approved and grounded. Check extension cord before use for damage, bent prongs, and cuts. Replace if damaged.

**Always make your extension cord connection on the charger side first.** After connecting the extension cord to the charger proceed to plug the extension cord to a nearby 120 VAC GFCI protected (Ground Fault Circuit Interrupt) outlet.

**Always remove the extension cord from the 120 VAC outlet first when charging is completed followed by unplugging the charger.**

## General Overview

The ProSport Charger is an Advanced Electronic and Fully Automatic Multi-Stage On-Board Marine Battery Charger. ProSport is pre-wired for easy installation and is 100% waterproof for fresh and salt water applications.

ProSport's Sequential Multi-Stage Charging process delivers three sequenced modes of operation that include: Charging, Conditioning, and Maintenance of each battery. This process is proven to extend the life of your batteries and will fully charge your batteries each time.

ProSport's Heavy Duty extruded aluminum housing delivers increased power and performance while providing improved durability and heat transfer.

The ProSport's Distributed-On-Demand™ Charging Technology will automatically sense and distribute 100% of the available charging amp output, 8, 12, or 20 amps (model specific) to any one battery or combination of all batteries. Each battery charger output is fully isolated.

ProSport's easy to view LED indicators will provide at a glance status of: AC power, Battery Type, Charging, and Ready Status. The LED Status Center can be seen on the top of the unit when installed.

*Note: ProSport Waterproof Marine Battery Chargers are designed for any combination of group 24, 27, 30 and 31 batteries. Each Battery Charger DC output cable must be connected to one (1) 12 Volt DC battery (even if batteries are configured for 24 Volt DC or 36 Volt DC trolling Motor or System Applications). Most specifically you do not have to remove series or parallel jumper cables to use your ProSport Charger. See typical wiring diagrams for these systems in the installation section of this manual.*

**Note: If your application is for 4D or 8D large capacity batteries, please refer to ProMariner's website [www.promariner.com](http://www.promariner.com) and view our ProTech-1 and ProNautic C3 Line of Dry Compartment Chargers. Using our online selector guide, choose a model that best fits your application for this class of batteries.**

## Charging Batteries

The ProSport Series is designed to charge, condition, and maintain your batteries. Please follow these steps each time you use your ProSport Charger:

1. Open all battery compartments and ventilate for at least 15 minutes before applying AC power to your charger. While charging your batteries make sure to keep your battery compartment open allowing for free air ventilation.
2. Make sure all DC battery connections are tight and clean. Follow battery manufacturer's recommendations for battery cell caps. (loosen caps if applicable)
3. Connect a heavy duty UL approved extension cord to the ProSport Charger first. After connecting the extension cord to the charger, proceed to plug the extension cord to a nearby 120VAC GFCI protected (Ground Fault Circuit Interrupt) outlet.
4. Assuming your batteries are discharged, and your ProSport is factory set for standard Flooded (Lead-acid) batteries, you should observe ProSport's Blue AC POWER LED Turn On, followed by the Red Charge LED and RED Battery Type LED Turning On (red is the factory setting of standard Flooded (Lead-acid)/AGM type batteries).
5. **The Sequential Multi-Stage Charging Process is complete when only the Green READY LED and the Blue AC POWER LEDs remain on indicating that your batteries are fully charged and are being maintained with a precision 13.4 Volts DC Finishing Voltage (Factory set charge profile for standard Flooded (Lead-acid / AGM Batteries). ProSport's Ready/Maintenance Mode is perfect for short or long term storage and will never overcharge your batteries.**

**Performance Tip:** For long term or winter storage/maintenance of batteries, ProMariner recommends that every 30 days: AC power is removed by unplugging your extension cord at the GFCI outlet first, Check Battery Electrolyte levels. Re-apply AC Power to your ProSport Charger. This practice will properly maintain your batteries resulting in extended battery life and use.

6. When you are ready to use your boat, unplug your extension cord at the GFCI outlet first, followed by unplugging the charger.

ProSport Series Typical Trolling/House/Engine Battery Wiring Diagrams

**Fig. 5 ProSport20 Plus Triple Output Charger for 3 Batteries Maximum Typical**

Dedicated 36 VDC Trolling Motor Battery Configuration with (3) 12 VDC Batteries Connected with (2) Series Jumpers

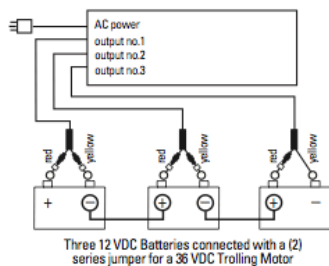

**Fig. 6 ProSport 8, 12, & 20 Dual Output Charger for 2 Batteries Typical**

Dedicated 12 VDC Parallel Trolling Motor or House Configuration

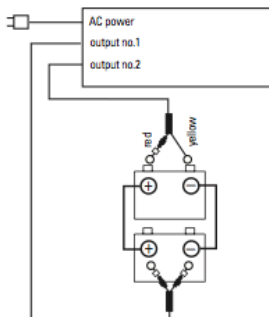

**Fig. 7 ProSport 8, 12, & 20 Dual Output Charger for 2 Batteries Typical**

Dedicated 12 VDC House Battery and one (1) Engine Start Battery or Dual Engine Start Battery Configuration

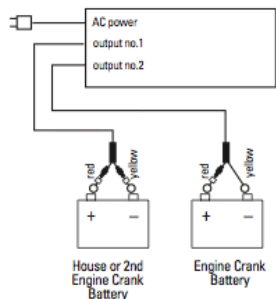

**Fig. 8 ProSport20 Plus Triple Output Charger for 3 Batteries**

Dedicated 12 VDC Bank and 2 Engine Engine Crank Batteries Typical Configuration

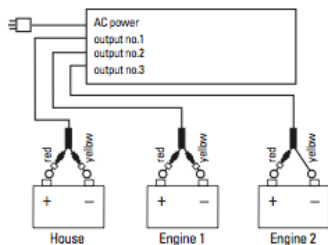

Note:  
 Indicates Jumper Series  
 Indicates Fuse

Distributed-On-Demand™ Charging Versus Standard Chargers.

ProSport's "Distributed-On-Demand™" feature will automatically distribute 100% of its available charging amps of 8, 12 or 20 amps (model specific) to any one battery or combination of all batteries. This feature ensures all available charging amps are used, unlike other 2 and 3 bank On-Board Chargers with a fixed amp limit per charger bank/ DC output cable.

Distributed-On-Demand™ Technology Advantage versus Leading Fixed Amp per Bank Chargers

Distributed-On-Demand™ Multi-Stage Charging Output

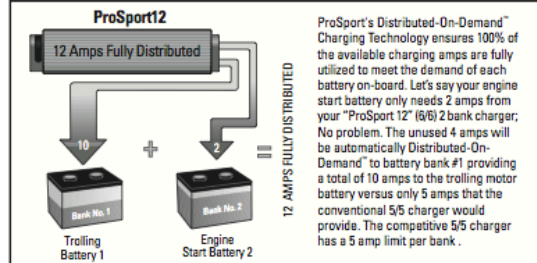

Typical Leading Competitive Charging Output

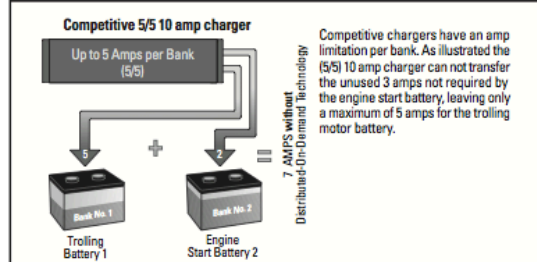

Note: Above illustration reflects typical battery usage after a day of fishing. Trolling motor batteries are 50% discharged and not usable. Engine start battery is 90% charged from the engine charging system.

### General Operation

Install your ProSport On-Board Marine Battery Charger to the guidelines in this manual.

Make sure your charger and batteries are properly vented. Connect your extension cord with no AC power present to the ProSport and proceed to plug your extension cord in at a nearby 120 VAC GFCI protected (Ground Fault Circuit Interrupt) outlet.

With your ProSport plugged in properly, it will automatically / fully charge your batteries while it conditions and extends the life of your batteries. When you're not at home, always leave your charger plugged in to reduce sulfate build-up allowing your batteries to be fully charged and maintained for your next fishing trip.

For long term or winter storage/ maintenance of batteries, ProMariner recommends that every 30 days: AC Power is removed by unplugging your extension cord at the GFCI outlet first, check battery electrolyte levels. Re-apply AC power to your ProSport Charger. This practice will properly maintain your batteries resulting in extended Battery Life and Use.

### LED Status Center- Operation & Display

The ProSport Series includes four (4) LEDs as shown:

1. Top LED is Battery Type: Red for standard Flooded (Lead-acid)/AGM, Amber for AGM HP (High Performance) and Green for GEL
2. Ready LED: Illuminates Green
3. Charging LED: Illuminates Red
4. Bottom Power LED: Illuminates Blue



#### LED Status Center Operation after Applying AC Power to Discharged Batteries (Example below is for the factory setting of Flooded (Lead-acid) batteries)

The Blue AC Power LED will illuminate followed by the Red Charging LED and Red Battery Type LED (Factory Setting for standard Flooded (Lead-acid)/AGM Batteries). The combination of these three LEDs turning on indicates ProSport has started its Sequential Multi-Stage Charging process.

When the Sequential Multi-Stage Charge Process is completed you will observe the following:

- ✓ Battery Type Red LED goes OFF
- ✓ Charging Red LED goes OFF
- ✓ Ready Green LED turns ON

*The only LEDs on after the Sequential Multi-Stage Charge process is completed are the Blue AC Power LED and the Green Ready LED*

#### LED Status Center Operation after Applying AC Power to Fully Charged Batteries

The Blue AC Power LED will illuminate followed by the Green Ready Indicator turning ON

For this application, the following LEDs are in the OFF state.

- ✓ Battery Type (factory set) Red LED Turns OFF
- ✓ Charging Red LED Turns OFF.

*The only LEDs on, if the charger is maintaining fully charged batteries, are the Blue AC power LED and the Green Ready LED.*

### ProSport Series Typical Trolling/House/Engine Battery Wiring Diagrams

ProSport Wiring Diagrams for Typical Installations of 12 Volt DC and 24 Volt DC Trolling Motor Battery Configurations with a Dedicated Engine Start Battery. (ProMariner recommended configuration.)

**Fig. 1 ProSport 6, 12, & 20 Dual Output Charger for 2 Batteries Maximum Typical**

12 VDC Trolling Motor or House Battery Configuration Plus Dedicated 12 VDC Engine Start Battery

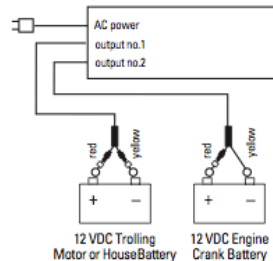

**Fig. 2 ProSport 20 Plus Triple Output Charger for 3 Batteries Maximum Typical**

24 VDC Trolling Motor or House Battery Configuration with (2) 12 VDC Batteries Connected with a Series Jumper Plus Dedicated 12 VDC Engine Start Battery

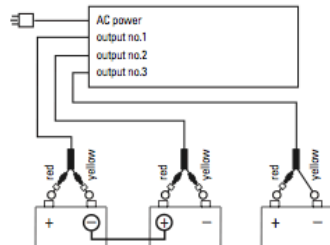

Two 12 VDC Batteries connected with a series jumper for a 24 VDC Trolling Motor

12 VDC Engine Crank Battery

Note:  
○ Indicates Jumper Series  
○—○ Indicates Fuse

ProSport Wiring Diagrams for Typical Installations of 12 Volt DC, 24 Volt DC and 36 Volt DC Dedicated Trolling Motor Battery Configurations. No Engine Start Battery.

**Fig. 3 ProSport 6 Single Output Charger for 1 Battery Maximum Typical**

Dedicated 12 VDC Trolling Motor, House or Engine Battery Configuration

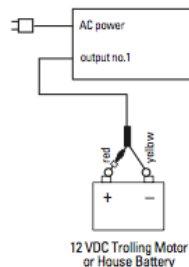

**Fig. 4 ProSport 8, 12, & 20 Dual Output Charger for 2 Batteries Maximum Typical**

Dedicated 24 VDC Trolling Motor Battery Configuration with (2) 12 VDC Batteries Connected with a Series Jumper

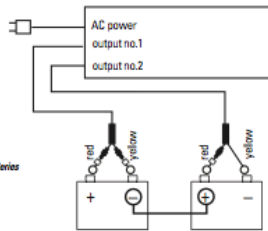

Two 12 VDC Batteries connected with a series jumper for a 24 VDC Trolling Motor

Note:  
○ Indicates Jumper Series  
○—○ Indicates Fuse

Note 1: One bank cable connects to no more than one battery

Note 2: ProSport is designed to be used with group 24, 27, 30 and 31 batteries



## Installation (Continued)

7. Run your cables free from sharp objects and hold each of them in place with cable ties. Coil excess cable, **do not cut or shorten the length of the cables**, as there are in-line fuses located 4 inches from the end of each red (positive) cable. In addition, there are fuses in all but one of the yellow (negative) leads. These fuses are in place to protect the charger and output cables in the event of a short or reverse polarity.

8. Connect the DC output cables as illustrated on page 10. Make sure the (yellow) wires are connected as illustrated to the negative side of the battery and the red wires are connected to the positive side of the battery.

9. Make sure all DC connections are correct, tight, and free from corrosion.

10. Locate the AC power cord in an open-air area of your boat at least 21 inches from the charger, batteries, and fuel fill lines.

11. Connect a heavy duty UL approved extension cord to the ProSport Charger first. After connecting the extension cord to the charger, proceed to plug the extension cord to a nearby 120VAC GFCI protected (Ground Fault Circuit Interrupt) outlet. Always remove the extension cord from the 120VAC outlet first when charging is completed, followed by unplugging the charger.

You are now connected and charging your batteries. View the LED indicators.

Assuming your batteries are discharged you should observe: Blue AC POWER LED is turned on, followed by the Red Charge LED and RED Battery Type LED turning on (red is the factory setting of flooded (Lead-acid)/AGM type batteries).

## ProSport DC Output Cable Wiring Diagrams-Typical Installations

*Note: ProSport Waterproof On-Board Marine Battery Chargers are designed for any combination of Group 24, 27, 30 and 31 batteries. Each Battery Charger DC output cable must be connected to one (1) 12 Volt DC battery (even if batteries are configured for 24 Volt DC or 36 Volt DC trolling Motor or System Applications). See typical wiring diagrams for these systems on page 10.*

ProSport Dual Bank Models can charge (2) independent or parallel 12 Volt DC Batteries or a 24 Volt DC Bank Configuration of: (two 12 Volt DC batteries in series) and our ProSport Triple Bank Model can charge (3) Independent or parallel 12 Volt DC batteries or a 36 Volt DC configuration of: (three 12 Volt DC batteries in series). Please see our typical wiring diagrams for 24 Volt DC and 36 Volt DC bank configurations and more. Simply attach each battery charger DC output cable to one 12 Volt battery. Because each output is isolated, all parallel or series jumper wires can remain connected to your batteries. Specifically you do not have to remove series or parallel jumper cables to use your ProSport Charger.

**Note:** If your application is for 4D or 8D large capacity batteries, please refer to ProMariner's website [www.promariner.com](http://www.promariner.com) and view our ProTech-i and ProNautic C3 Line of Dry Compartment Chargers. Using our online selector guide choose a model that best fits your application for this class of batteries.

## Sequential Multi-Stage Charging Overview

Upon applying AC power to your ProSport On-Board Marine Battery Charger, the following will be observed:

The Blue AC Power LED will illuminate followed by the Red Charging LED and Red Battery Type LED (Factory setting for standard Flooded (Lead-acid)/AGM batteries). The combination of these three LED's turning on indicates ProSport has started its Sequential Multi-Stage Charging process. When the Charge Process is completed, only the Green READY and Blue AC Power LEDs will be illuminated.

ProSport's Sequential Multi-Stage Charging process delivers three sequenced modes of operation that include: Charging, Conditioning and Maintenance of each battery. This process is proven to extend the life of your batteries and will fully charge your batteries each time.

### Stage 1: ProSport Charging

During this mode, the ProSport will use its available charging amps (as controlled by temperature) until battery voltage is raised to 14.6 VDC (Factory setting for standard Flooded (Lead-acid) / AGM batteries).

### Stage 2: ProSport Conditioning

The ProSport will hold batteries at 14.6 VDC (Factory setting for Flooded (Lead-acid) / AGM batteries) providing a 100% charge to each battery, while conditioning batteries by desulfating each battery. Upon completion, the ProSport will go to into its maintenance mode.

### Stage 3: ProSport Ready / Maintenance Mode

During this mode, the Red Charging LED and the RED Battery Type LED (Factory set charge profile for standard Flooded (Lead-acid) / AGM Batteries) will turn off indicating the Charge Process is completed, followed by the Green READY LED turning On.

The Green READY LED and the Blue AC POWER LED will remain on indicating that your batteries are fully charged and are being maintained with a precision 13.4 Volts DC Finishing Voltage (Factory set charge profile for standard Flooded (Lead-acid) / AGM Batteries). ProSport's Ready/Maintenance Mode is perfect for short or long term storage and will never overcharge your batteries.

*Note: Only the Green READY LED and the Blue AC POWER LED will remain on when the ProSport is in its Ready/Maintenance Mode.*

### Average Voltage - Standard Flooded (Lead-acid) / AGM Charger Profile

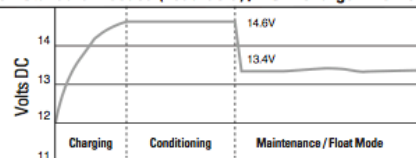

**Performance Tip:** For long term or winter storage/maintenance of batteries, ProMariner recommends that every 30 days; AC power is removed by unplugging your extension cord at the GFCI outlet first, check battery electrolyte levels. Re-apply AC power to your ProSport Charger. This practice will properly maintain your batteries resulting in extended battery life and use.

## ▶ Selecting a Charging Profile & Understanding Battery Types

Your Battery Charger is equipped with a user programmable battery type selector that is factory set for standard Flooded (Lead-acid) / AGM (Absorbed Glass Mat) batteries.

To set your charger for high performance AGM or GEL batteries simply remove the black programming cap and replace it with either the red AGM HP or gray GEL programming cap. Any time you reprogram or change the cap, apply marine silicone to the threads of the cap being installed.



**Note: It is the color and internal design of the cap that determines the charge profile, not the alignment of the debossed letters for the battery type on the cap.**

**Please be sure to keep your unused programming cap.**

## ▶ Understanding Battery Types & Charger Settings

There are three primary types of batteries in the marketplace today; standard Flooded (Lead-acid), AGM (Absorbed Glass Mat), high performance AGM and GEL cell (Gelled Electrolyte Lead-acid). Traditionally, the most common type of batteries used are Flooded (Lead-acid) batteries.

Almost all GEL cell batteries will state that they are GEL cell on the battery case or labels. Shown below are typical battery voltages at absorption and float levels.

LED color	Battery Type	Charging Profile	Cap
Red	Standard Flooded (Lead-acid) - with or without fill caps AGM (Absorbed Glass Mat) - Sealed	14.6 VDC Absorption, 13.4 VDC Float	Black
Green	GEL Cell - Sealed Gray Cap	14.1 VDC Absorption, 13.8 VDC Float	Gray
Amber	AGM High Performance (Absorbed Glass Mat) - Sealed	14.7 VDC Absorption 13.6 VDC Float	Red

**NOTE: AGM (Absorbed Glass Mat) batteries are not GEL (Gelled Electrolyte Lead-acid) batteries and require a completely different charge profile that must be selected versus the out of the box factory setting. AGM batteries can accept the same charging profile as Flooded (Lead-acid) batteries.**

\*\*\*If you are still unsure what kind of battery(s) you have, we recommend that you contact the manufacturer of the battery(s).

## ▶ Installation

**All ProSport Battery Chargers are designed to be permanently mounted on-board, and should be mounted with extruded fins placed horizontally.**

Always mount your ProSport in a compartment area that can be properly ventilated during use.

Do NOT mix battery types on-board. All batteries should be of the same age and in good operating condition.

Do NOT make any electrical connections to the ProSport or batteries until the following steps are completed:

### 11 Easy to follow installation steps:

1. Select a mounting location that allows for free air ventilation with a minimum of 8 inches

## ▶ Installation (Continued)

of clear unobstructed space around and in front of the ProSport On-Board Marine Battery Charger. Open all battery and engine compartments and ventilate for at least 15 minutes before starting the installation of the ProSport Charger.

2. Confirm the selected mounting location allows for a minimum of 8 inches of free space around front and sides of the ProSport charger. Do not install charger on carpeted, upholstered, vinyl, or varnished areas. Be sure to place the ProSport in an accessible area where all indicators are viewable. Confirm all battery cables can reach each of the batteries.

**Note: For installations requiring an extension of the DC Battery Charger Cables, please call or visit your retailer or dealer to purchase ProMariner's 5 foot or 15 foot battery charger DC cable extenders. Our innovative cable extenders are properly fused and do not require any cutting or stripping of wires. If you have any problems locating this accessory call ProMariner at 1-800-824-0524.**

3. Using the ProSport as a template, mark the position of each mounting hole.

4. Using a 1/8" drill bit, drill pilot holes in the (4) marked locations as described in step 3. Apply a silicon sealer in each of the mounting locations to waterproof the screw holes.

5. Position the ProSport over the mounting holes and secure with a power screwdriver by installing 4 stainless steel screws. (**mounting screws not included**)

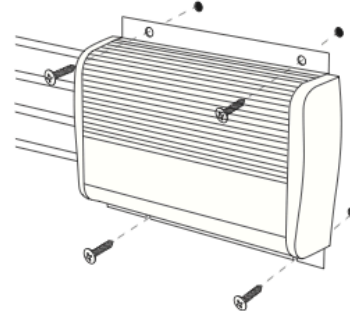

### IMPORTANT NOTICE

Confirm the surface you will be mounting the charger to is adequate in strength and thickness to hold the ProSport in place with the mounting screws you have selected.

Maintain an obstruction free area of 8 inches around the ProSport On-Board Marine Battery Charger

6. Prepare each battery in advance by cleaning each terminal post with a wire brush until a shiny surface is obtained.

### IMPORTANT NOTICE

As you prepare to attach the positive (red) and negative (yellow) charger output leads to the batteries there will be brief low power spark that is generated as you make the connection. This is due to the high frequency capacitors taking a charge. Make sure the (yellow) wires are connected as illustrated to the negative side of the battery and the red wires are connected to the positive side of the battery, as illustrated on pages 10 and 11.